

MAEW

INVERSIONES Y CONSTRUCCIONES MAEW SAS

CATALOGO DE PRODUCTOS

www.inversionesyconstruccionesmaew.com

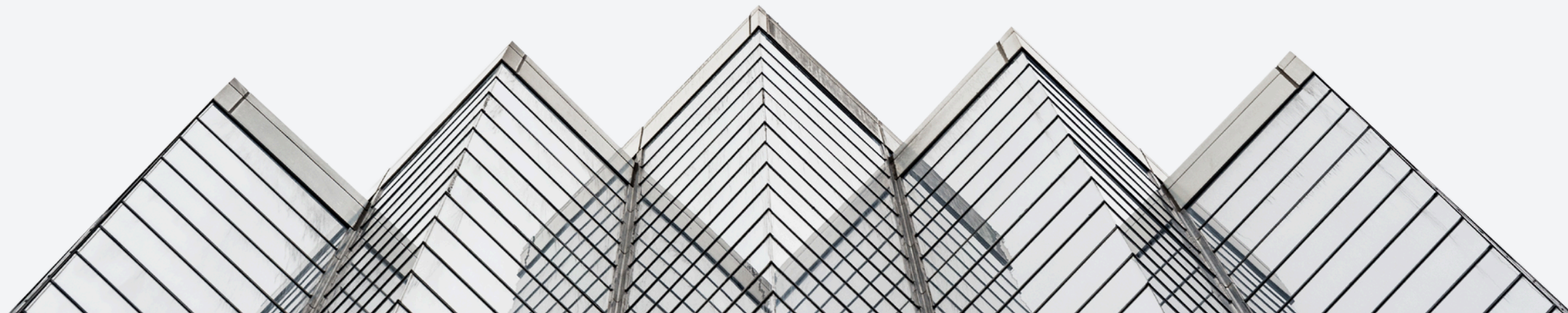

NUESTRA EMPRESA

Somos una empresa líder con más de 15 años de experiencia en la fabricación de prefabricados de concreto de alta calidad para el sector construcción. Nos destacamos por ofrecer productos duraderos y resistentes, consolidándonos como un referente en la industria gracias a nuestro compromiso con la excelencia y la satisfacción del cliente.

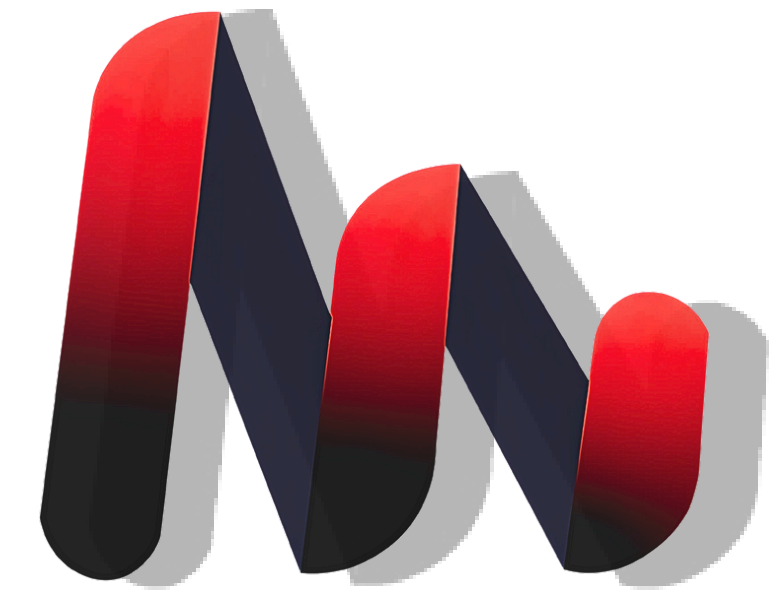

MAIEW

INVERSIONES Y CONSTRUCCIONES MAIEW SAS

RECOMENDACIONES

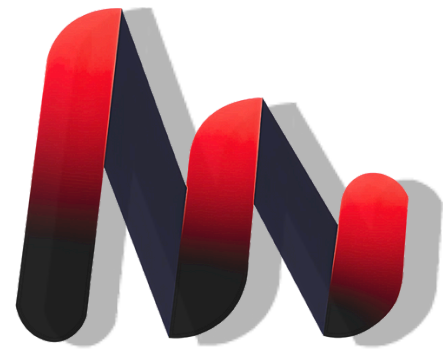

MAEW

INVERSIONES Y CONSTRUCCIONES MAEW SAS

Lee los códigos QR con tu dispositivo celular o presiona en el link y obtén la ficha técnica del producto seleccionado.



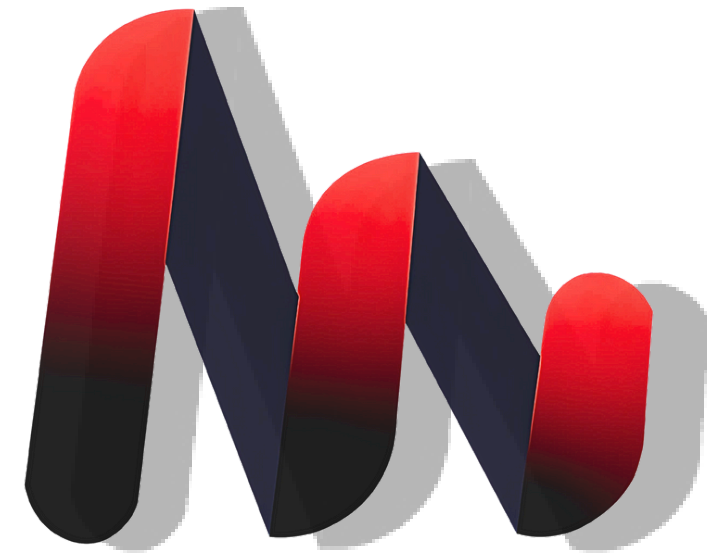

MAEW

INVERSIONES Y CONSTRUCCIONES MAEW SAS

PISOS FLOTANTES

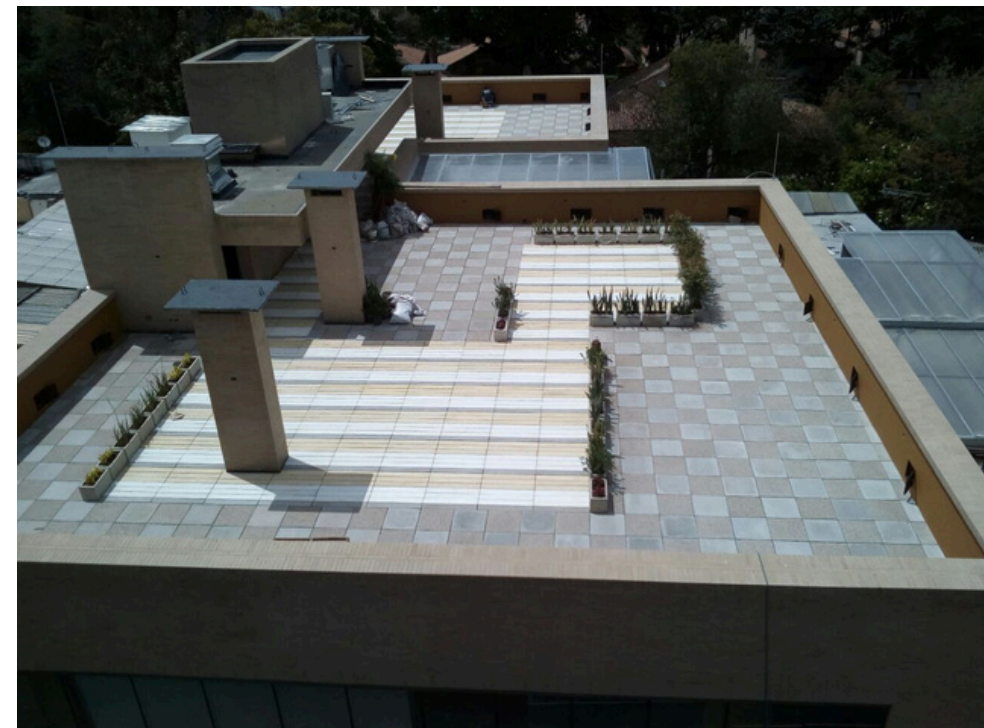

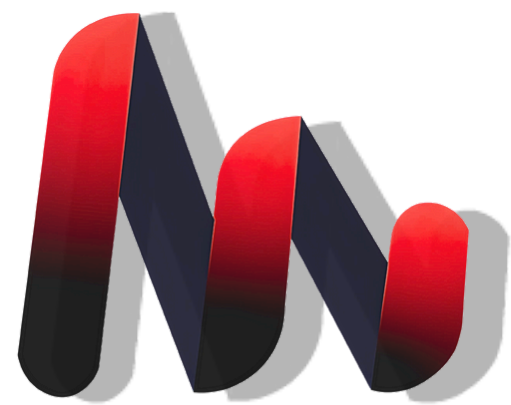

MAIEW

INVERSIONES Y CONSTRUCCIONES MAIEW SAS

PLAQUETAS CUADRADAS

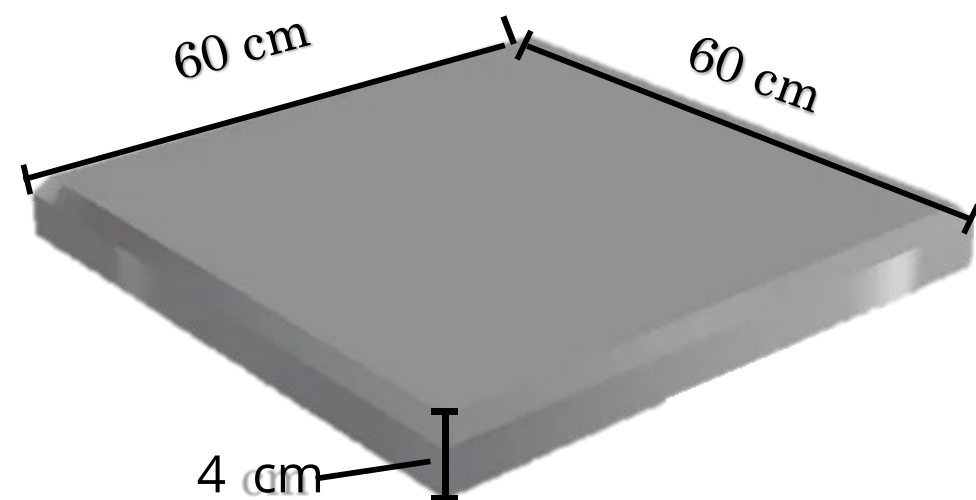

Peso: 32 kg
Resistencia de 3000 psi



DECK EN CONCRETO

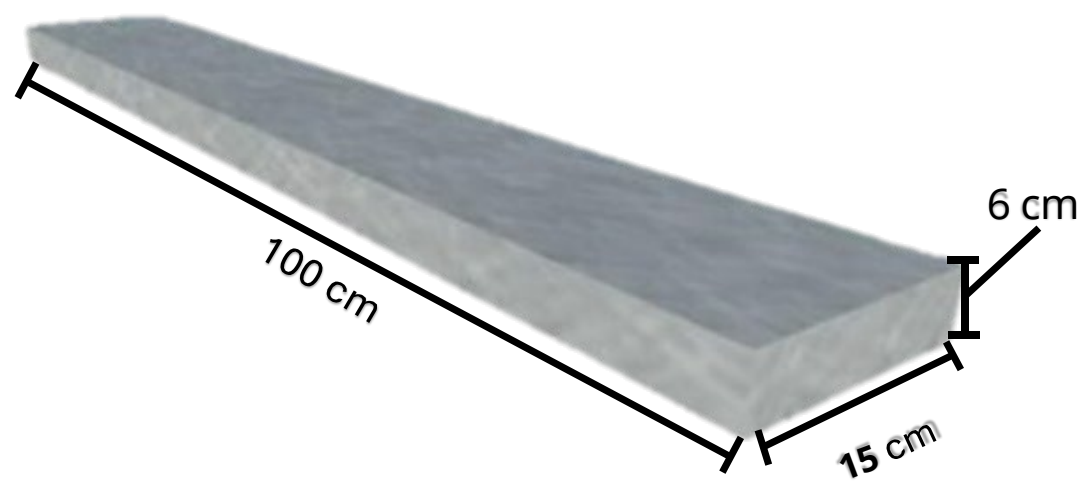

[Lista Pisos Flotantes](#)

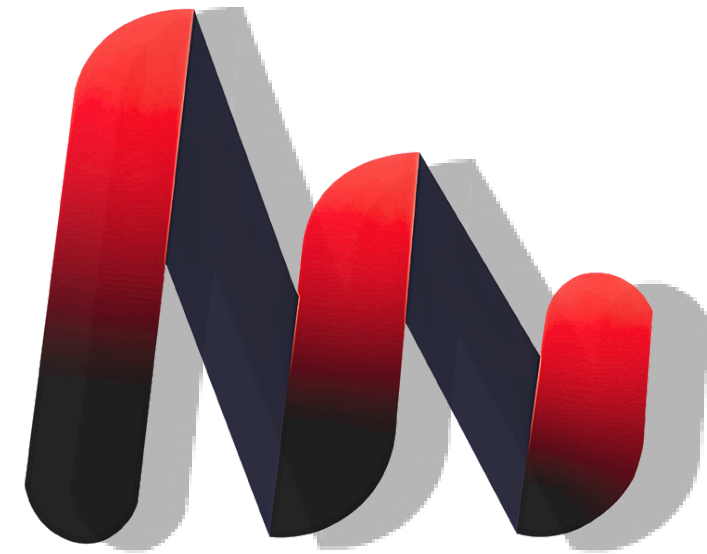

MAEW

INVERSIONES Y CONSTRUCCIONES MAEW SAS

URBANISMO



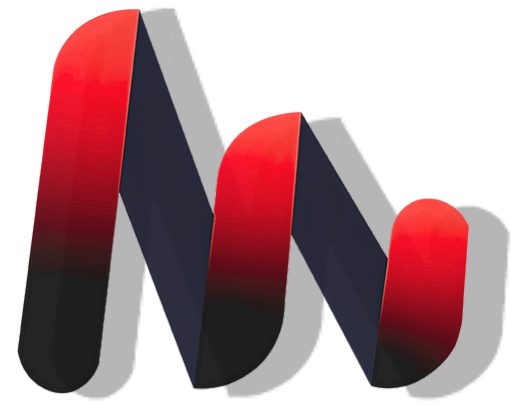

MAIEW

INVERSIONES Y CONSTRUCCIONES MAIEW SAS

⚡ TOPES PARA PARQUEADERO

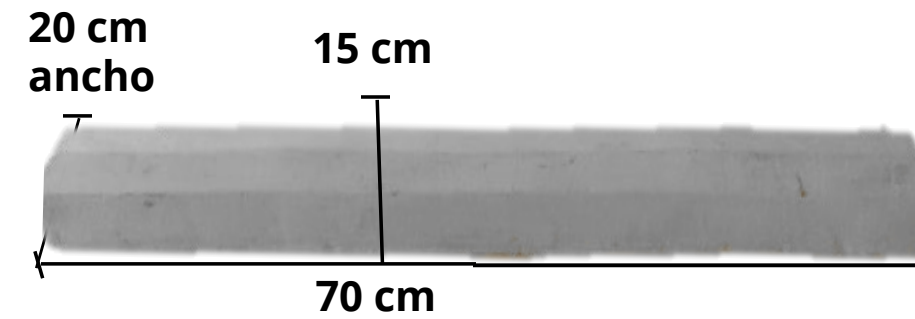
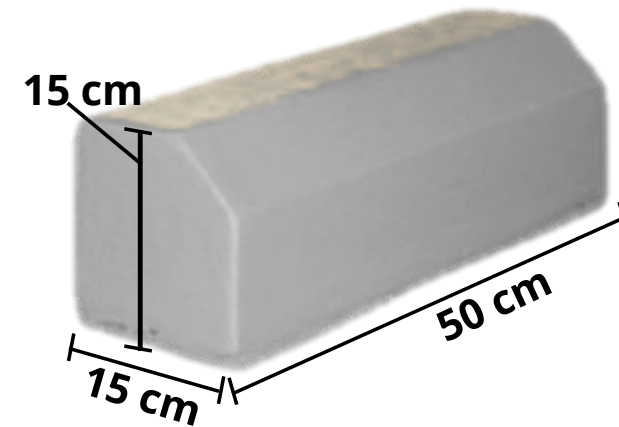
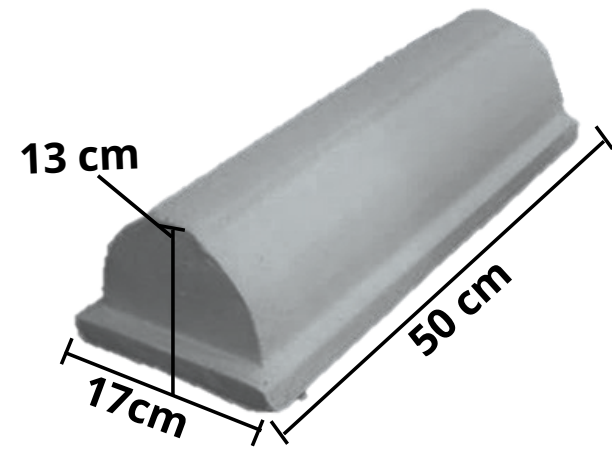

Peso: 40kg

⚡ GARGOLAS

Resistencia de **3000** psi

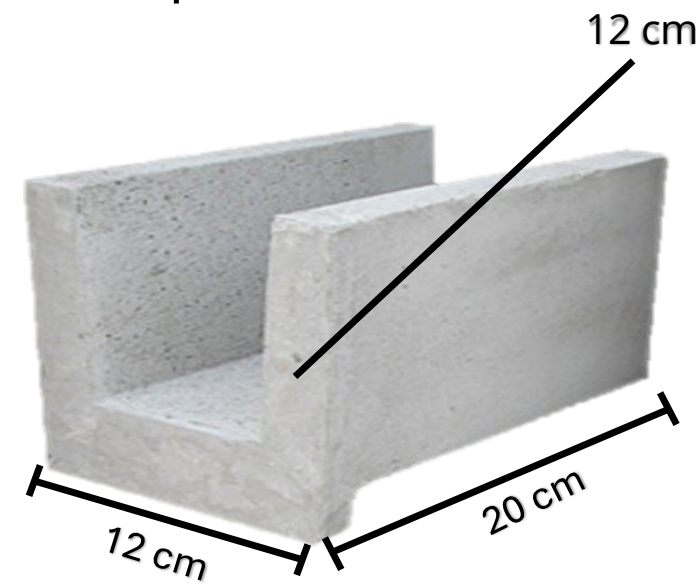
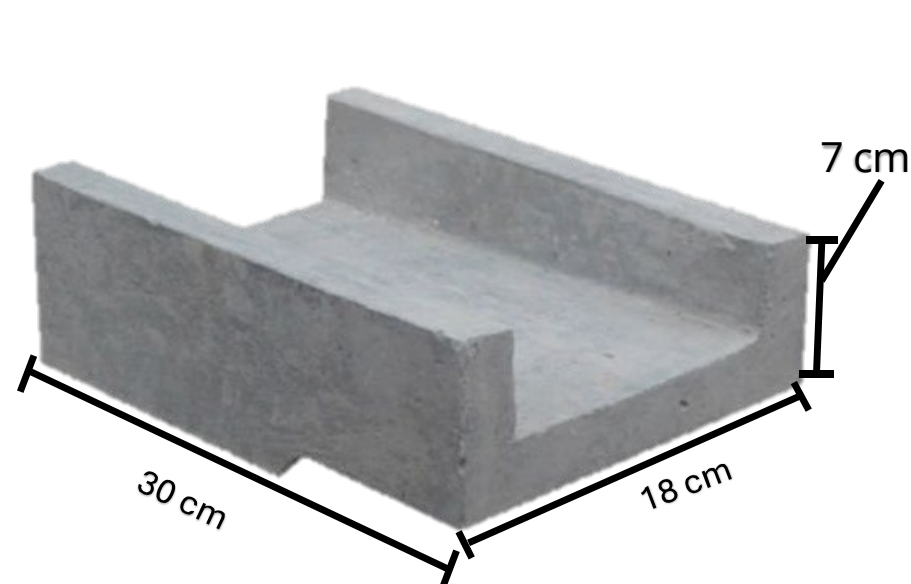

[Lista URBANISMO](#)



REJILLAS

Diseñadas para trafico peatonal (4 cm.), vehicular (6 cm.) y pesado (10 cm.) (espesor).

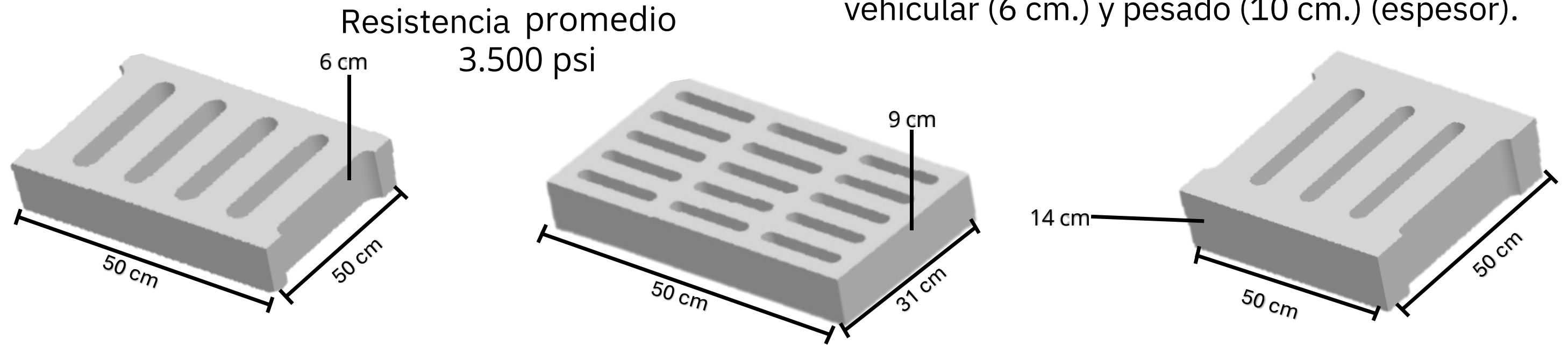

REMATES DE MUROS Y ALFAJIAS

Resistencia de 3000 psi



Medidas ajustables a las necesidades de los clientes que van desde 1.00 mt hasta 1.80 mt

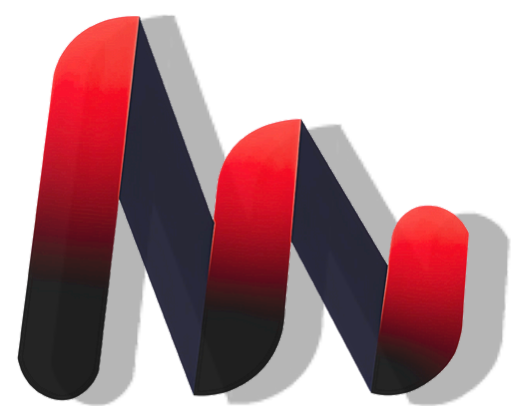

MAEW

INVERSIONES Y CONSTRUCCIONES MAEW SAS

ADOQUIN ECOLOGICO

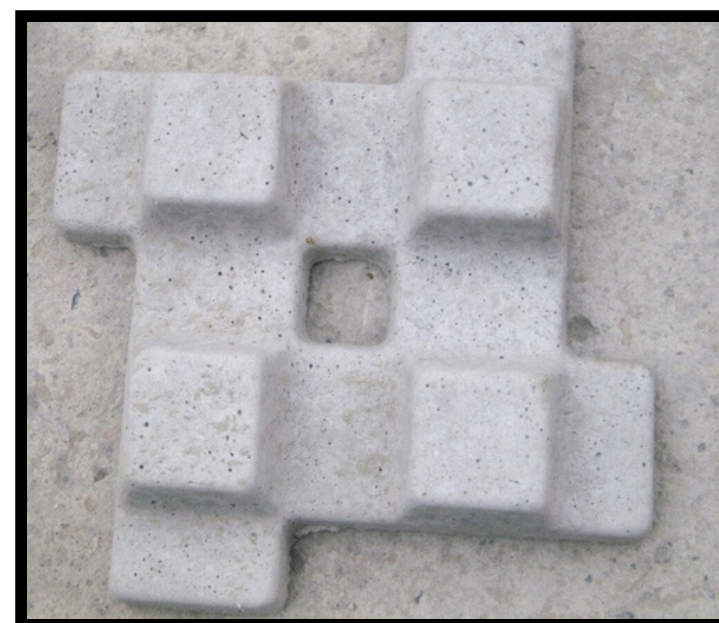

- Ancho: 35 cm.
- Largo: 35 cm.
- Espesor: 6 cm
- Resistencia de 2.500 psi
- Se usa en jardines y terrazas



ADOQUIN

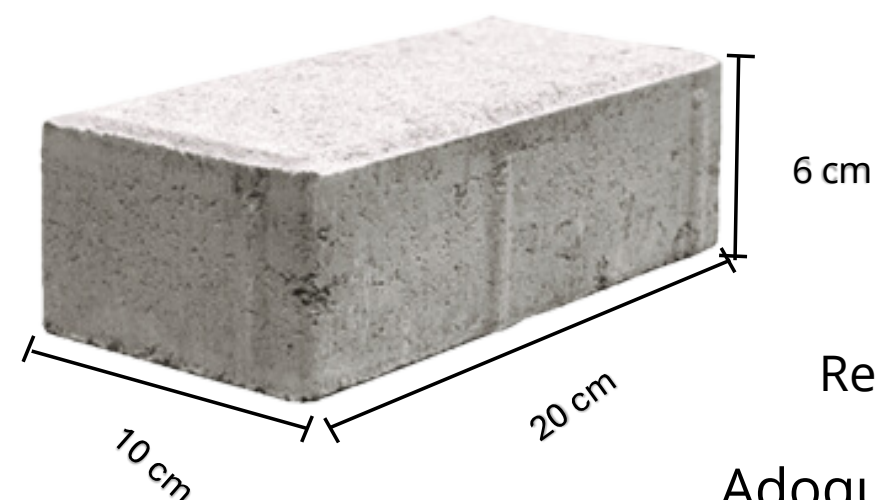

6 cm

10 cm

20 cm

Resistencia: 45 kgf

Adoquín rectangular de
concreto tráfico liviano
peatonal

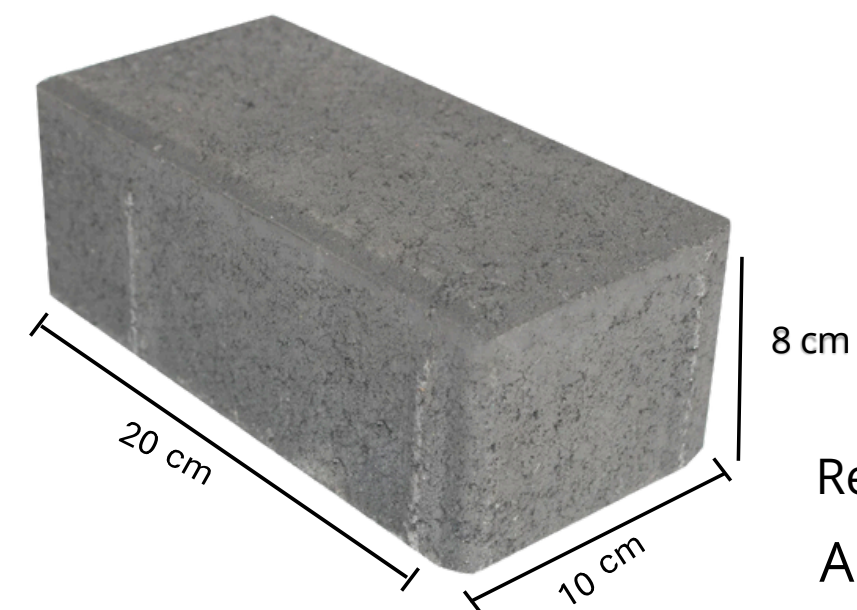

8 cm

20 cm

10 cm

Resistencia: 45 kgf

Adoquín rectangular de
concreto tráfico pesado
vehicular

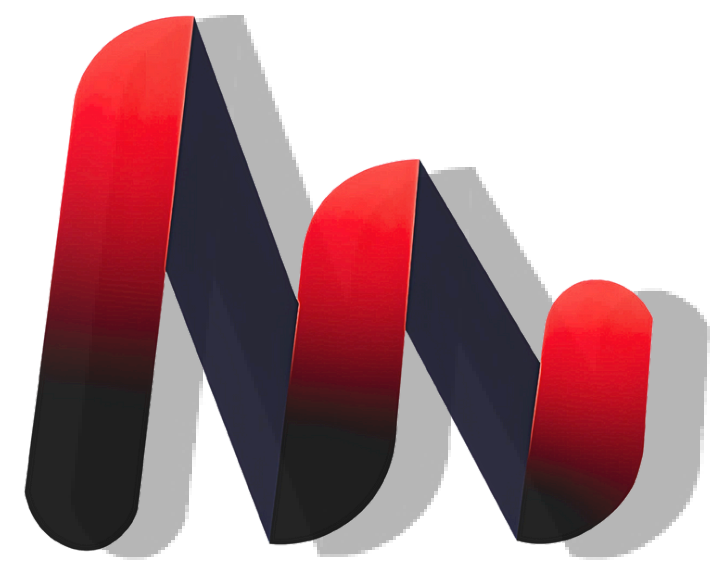

MAEW

INVERSIONES Y CONSTRUCCIONES MAEW SAS

PREFABRICADOS TIPO IDU



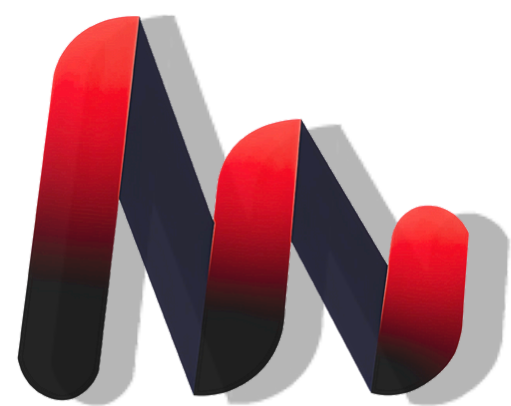

MAEW

INVERSIONES Y CONSTRUCCIONES MAEW SAS

Largo :40 cm
Ancho: 40 cm
Profundidad: 6cm

LOSETAS TIPO IDU

Resistencia de 3000 psi



Loqueta guía A-56
- 995

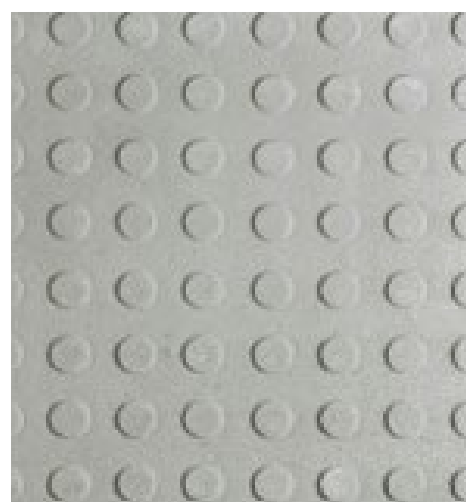

Loqueta táctil
alerta -55 - 603

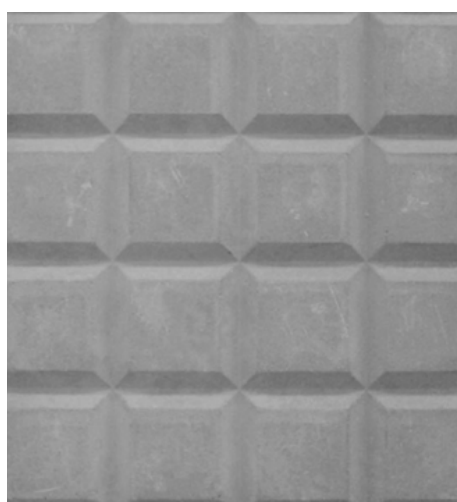

Loqueta
prefabricada A-50
- 114



Loqueta
prefabricada A-50
- 113



LISTA TIPO IDU

SARDINEL

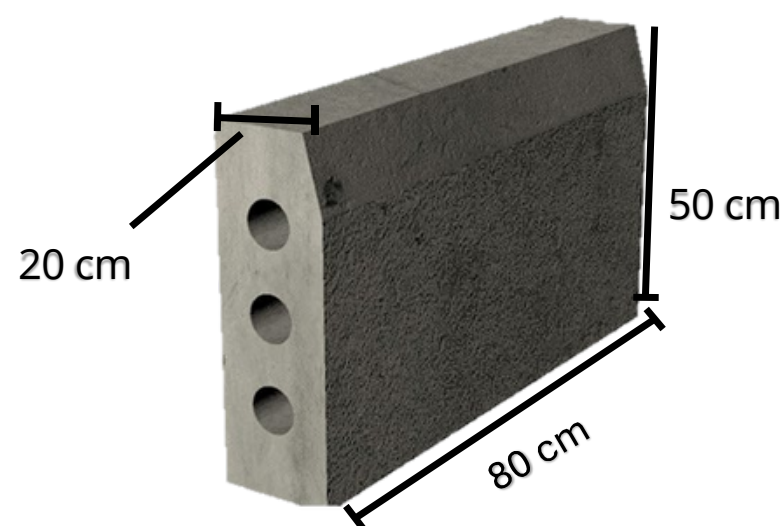

Resistencia 3000 psi
norma: ntc 4109

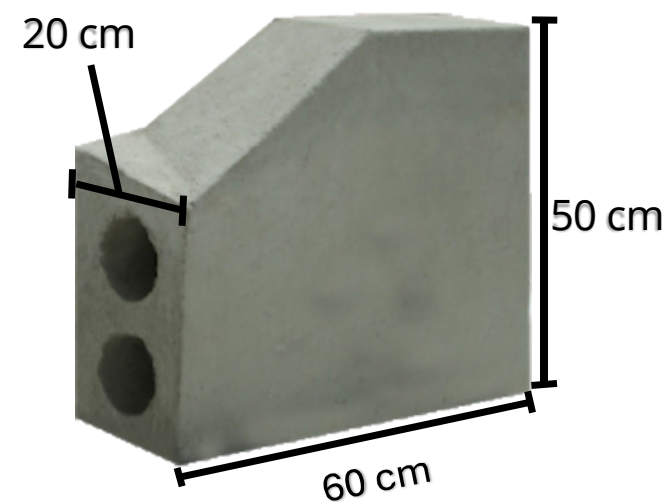

Resistencia 3000 psi
norma: ntc 4109

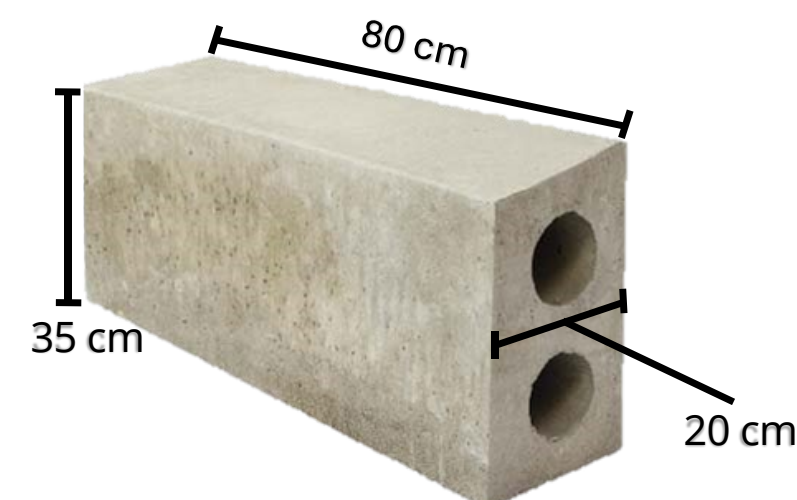

Resistencia 3000 psi
norma: ntc 4109

BORDILLOS Y CAÑUELAS

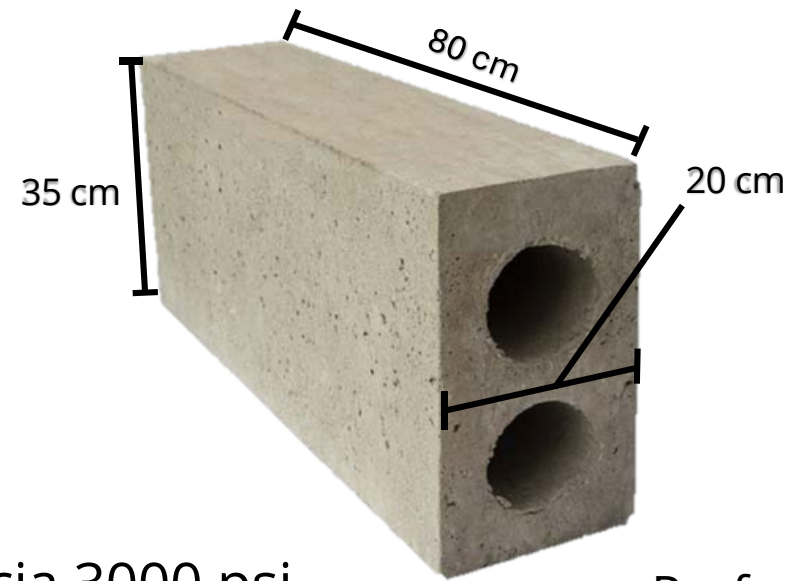

Resistencia 3000 psi
norma: ntc 4109

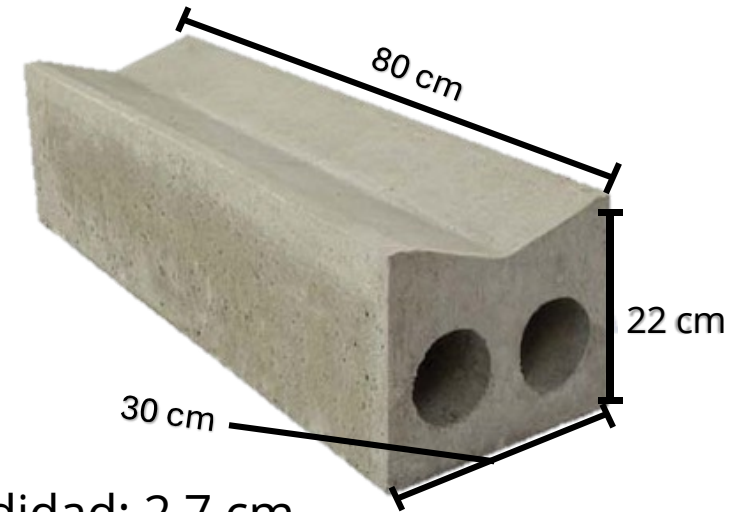

Profundidad: 2,7 cm
resistencia 3000 psi
norma: ntc 4109

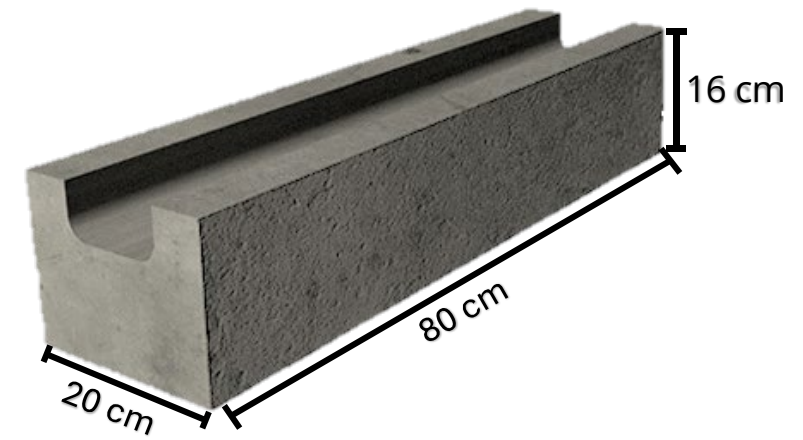

Profundidad: 5 cm
resistencia 3000 psi
norma: ntc 4109

BOLARDOS

bolardo M60
71X24



bolardo M63
105X14



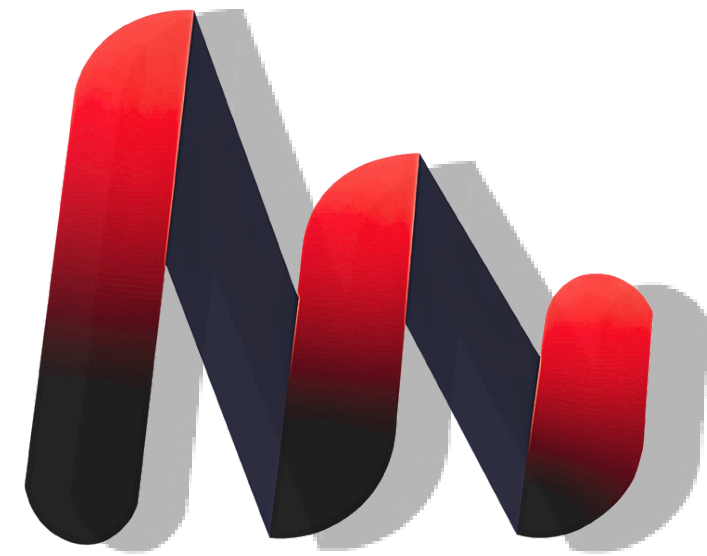

MAEW

INVERSIONES Y CONSTRUCCIONES MAEW SAS

PREFABRICADOS DECORATIVOS

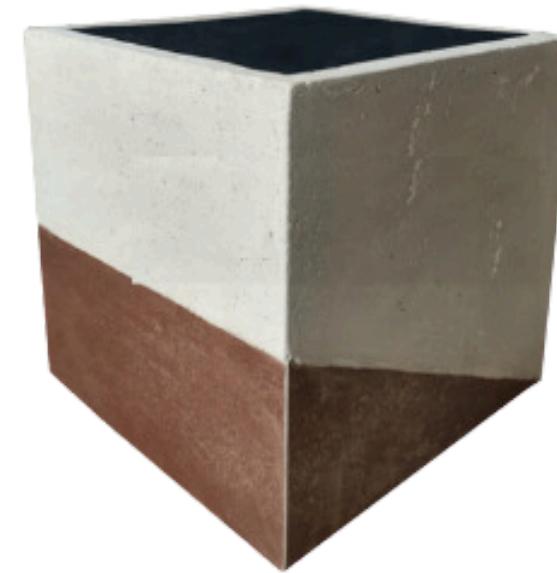

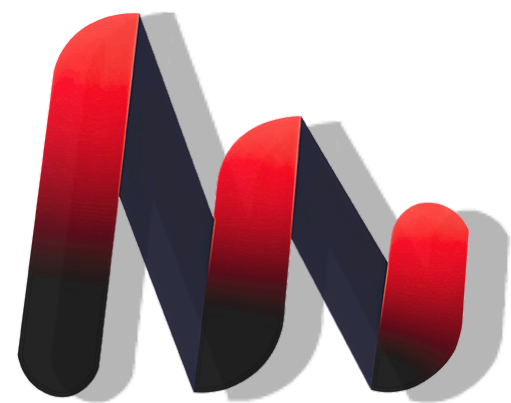

MAEW

INVERSIONES Y CONSTRUCCIONES MAEW SAS

MATERAS EN CONCRETO



Medidas: 100 cm largo x 40 cm ancho x 40 cm alto



Dimensiones: 66 cm diámetro x 33 cm alto



Dimensiones: 60 cm largo x 60 cm ancho x 60 cm alto



[CATALOGO MAEW MASETAS](#)

UBICACION SEDE ADMINISTRATIVA

Nuestra sede administrativa se encuentra en la Dg. 81i #72b-46, barrio Minuto de Dios, Bogotá. Desde esta ubicación estratégica, coordinamos eficientemente todas nuestras operaciones y aseguramos la máxima calidad en nuestros servicios y productos, garantizando un servicio excepcional a nuestros clientes.

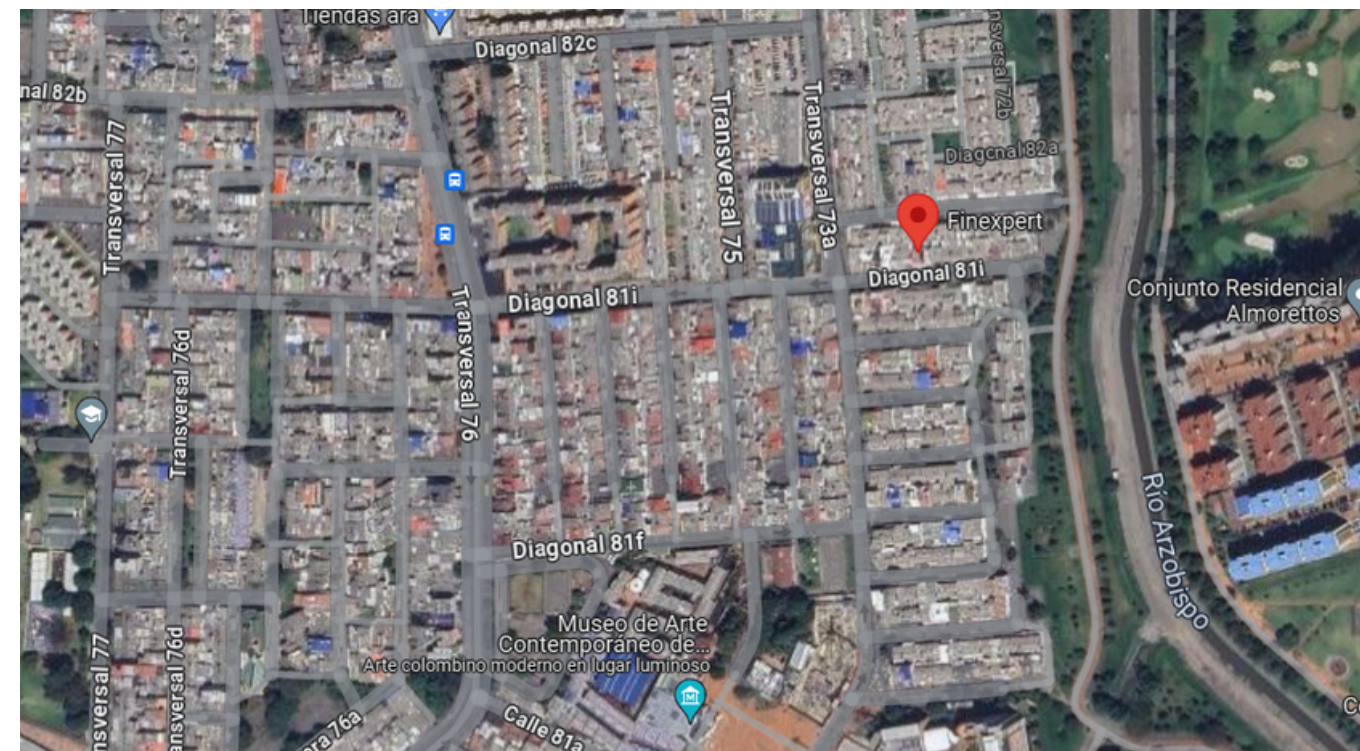

UBICACION PLANTA

Nuestra planta se encuentra ubicada en el Km. 5,7 de la vía Cajicá-Zipacquirá, un punto estratégico que facilita el acceso y distribución de nuestros productos de alta calidad a nivel departamental

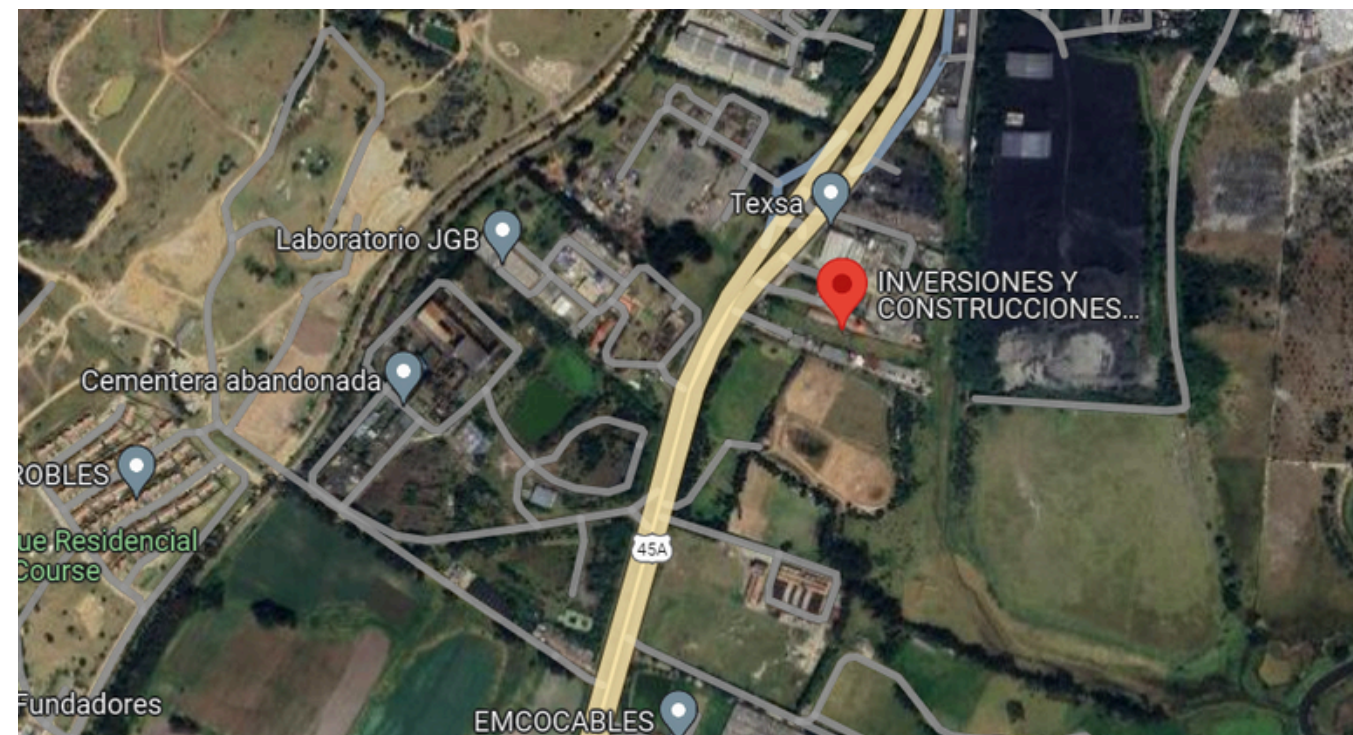

INFORMACIÓN DE CONTACTO

NUMERO CELULAR: 3043559967

CORREO: info@inversionesyconstruccionesmaew.com

PAGINA WEB: Inversionesyconstruccionesmaew.com

INSTAGRAM: @MAEW_CO

FACEBOOK: MAEW_CO



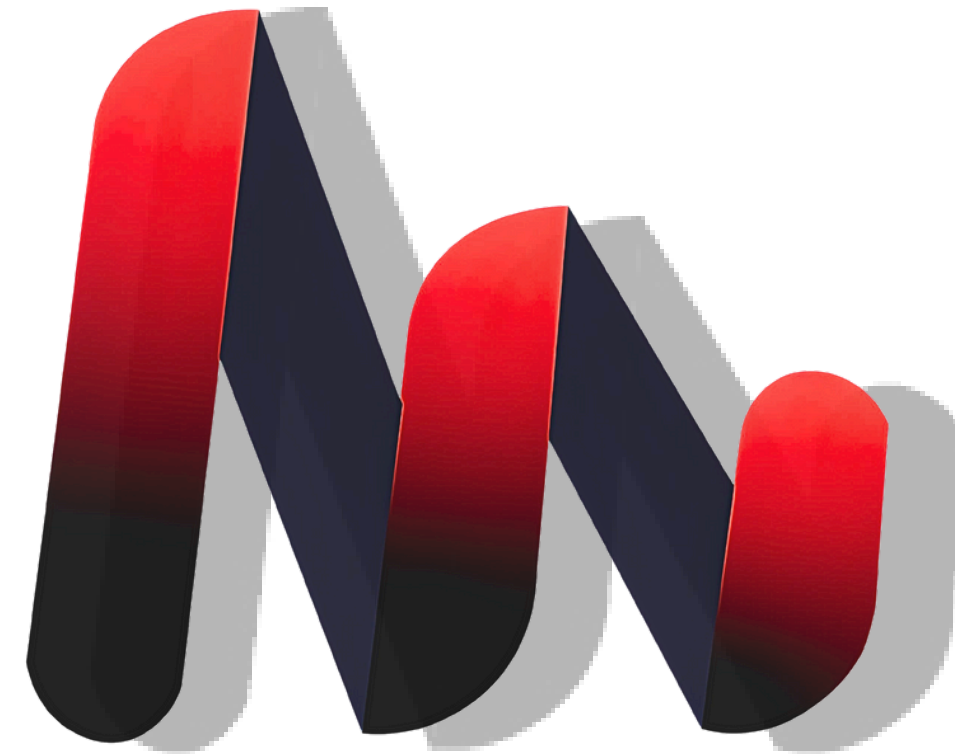

MAEW

INVERSIONES Y CONSTRUCCIONES MAEW SAS

www.inversionesyconstruccionesmaew.com

